

# fischer<sup>®</sup>technik

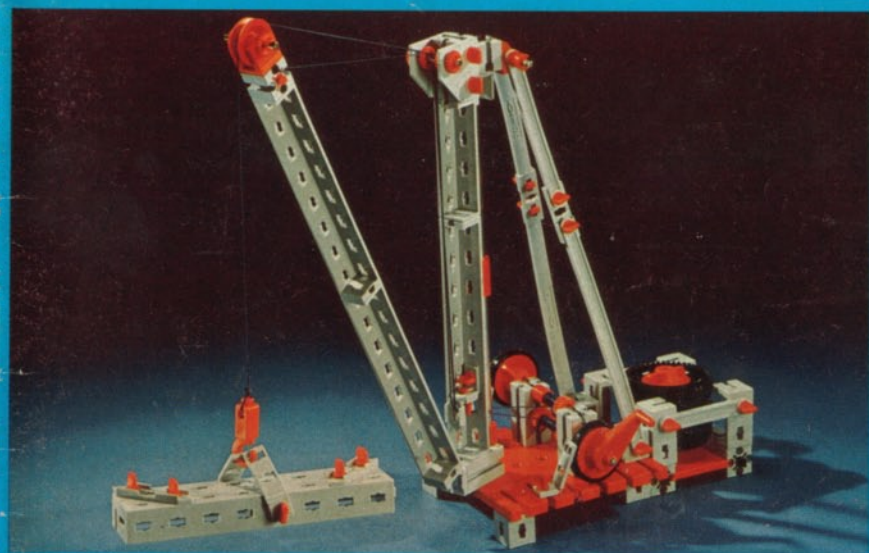

## 50S

Statikkasten  
structural set  
boîte «superstructure»  
cassetta statica  
statikadoos

Aufbaustufen  
der fischertechnik-  
Statikkästen  
extension packs for  
fischertechnik structural  
sets

▷ 100 S = 50 S + 50 S/1  
200 S = 50 S + 50 S/1 + 50 S/2  
300 S = 50 S + 50 S/1 + 50 S/2 + 50 S/3

possibilités d'extension  
des boîtes «superstructure»  
fischertechnik  
fasi d'ampliamento delle  
cassette fischertechnik  
statica  
uitbreidingsfasen van  
de fischertechnik  
statikadozen

**NEU**

Im Spiel-stabilen Baukasten

The fischertechnik construction system in a sturdy play box.  
En boîtes de rangement solides les systèmes de  
construction fischertechnik.  
Osservate ora la nuova cassetta resistente anche  
all'uso continuo il sistema della cassetta anche  
in costruzioni «fischertechnik».  
In bouwdozen speelbestendig van  
stootvast materiaal, gaan  
jaren mee.



Art. - Nr. 6 391205

**Handhabung · Usage · Mode d'emploi · Istruzioni per l'uso · Handleiding**

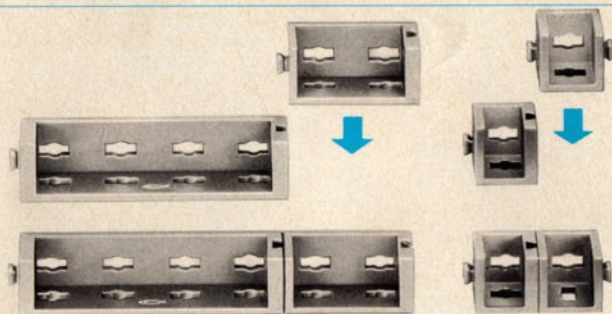

Zusammenfügen der Winkelträger.  
Joining the angle girders.  
Assemblage des cornières.  
Unione travi angolari.  
Het aan elkaar bevestigen van de hoekdraagsteunen.

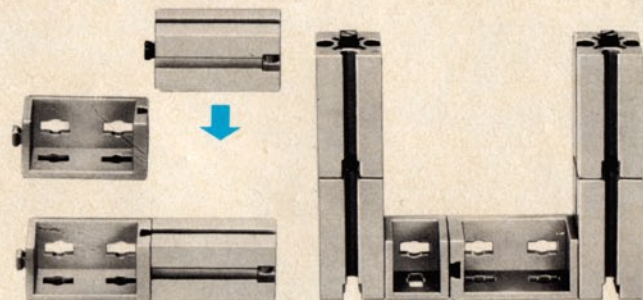

Scharnier in Verbindung mit Winkelträgern.  
Hinge in connection with angle girders.  
Charnière pouvant relier deux cornières.  
Cerniera in collegamento con travi angolari.  
Scharnier in combinatie met hoekdraagsteunen.

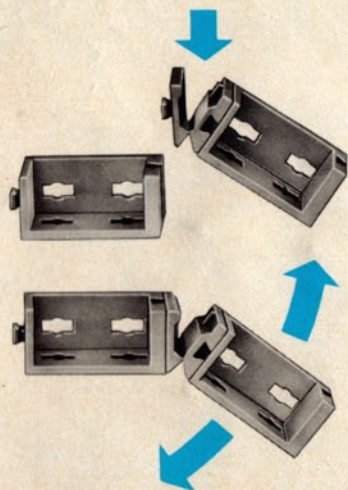

Verbinden von Winkelträgern mit Hilfe der Eckknotenplatte.  
Connecting angle girders by means of corner connector plate.  
Liaison entre cornières avec le gousset de coin.  
Collegamento di travi angolari con l'aiuto della piastra nodale angolata.  
Verbinding van hoekdraagsteunen met behulp van de hoekknoopplaat.

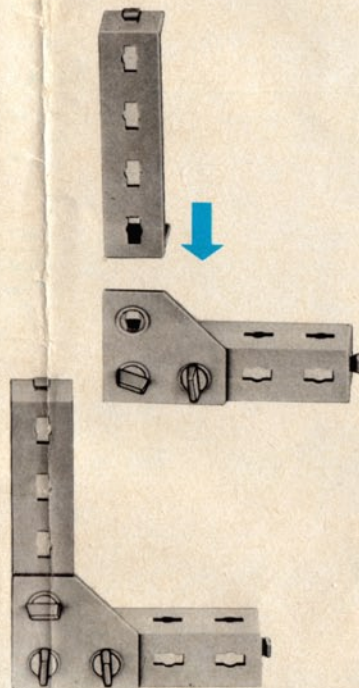

S-Riegel 4 zur Verbindung von Winkelträgern.  
Key-bolt 4 for connecting angle girders.  
Rivet S 4 pour liaisons de cornières.  
Chiavistello 4 per il collegamento di travi angolari.  
S-grendel 4 ter verbinding van hoekdraagsteunen.

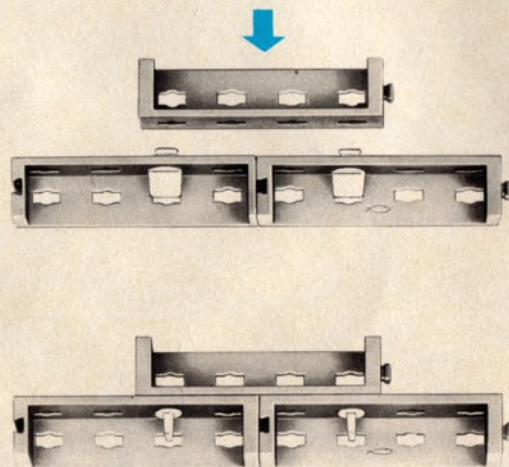

**Verbinden der Winkelträger mit Bausteinen.**  
 Connecting the angle girders with building blocks.  
 Liaison entre cornières et éléments.  
 Collegamento delle travi angolari con elementi.  
 De verbinding van de hoekdraagsteunen met  
 bouwstenen.

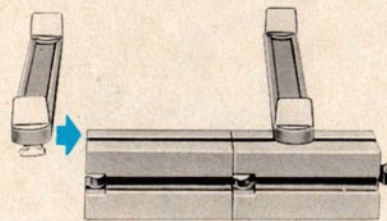
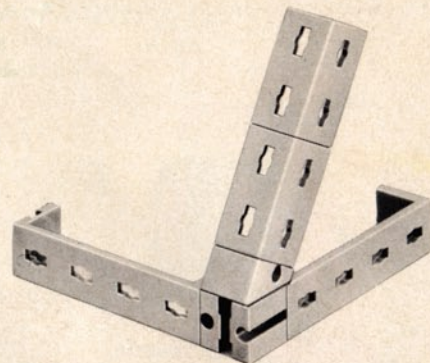
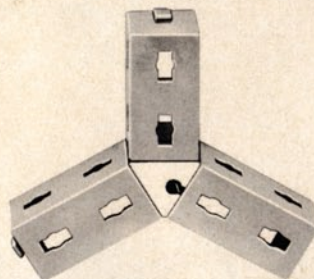
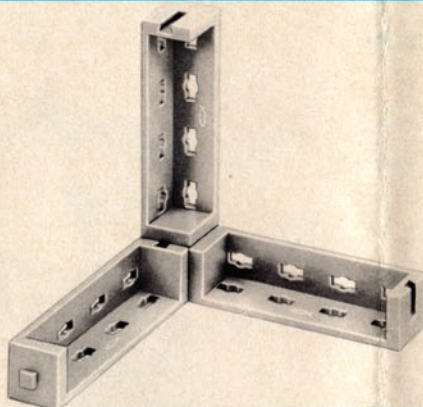
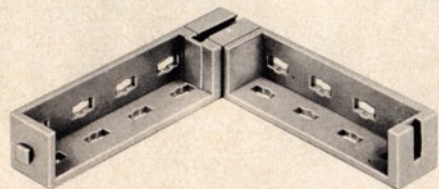

**Befestigen von Streben durch Einschieben des S-Riegels 4 in die Nut der Bausteine.**  
 Securing struts by inserting key-bolt 4 in the groove of the building blocks.  
 Fixation de contrefiches en insérant le rivet S 4 dans la rainure des pierres de construction.  
 Fissaggio di diagonali inserendo il chiovistello 4 nella scanalatura degli elementi.  
 Het bevestigen van spanten door inschuiven van de S-grendel 4 in de groef van de bouwstenen.

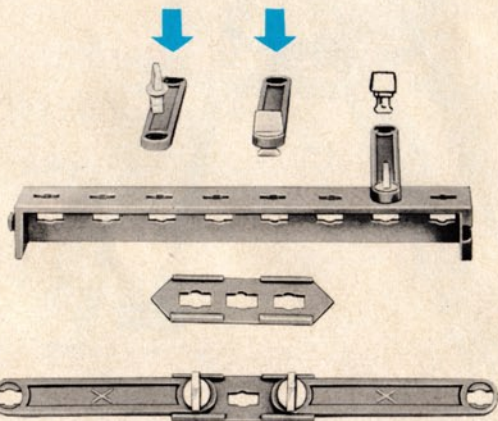

**Befestigen von Streben mit dem S-Riegel 4.**  
 Fastening struts with key-bolt 4.  
 Fixation de contrefiches avec le rivet S 4.  
 Fissaggio di diagonali con il chiovistello 4.  
 Befestiging van spanten met de S-grendel 4.

**Verwenden des S-Riegels 6 und S-Riegels 8.**  
 Use of key-bolt 6 and key-bolt 8.  
 Utilisation du rivet S 6 et du rivet S 8.  
 Impiego del chiovistella 6 e del chiovistello 8.  
 Toepassing van S-grendel 6 en S-grendel 8.

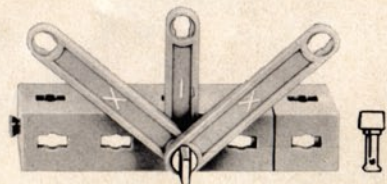
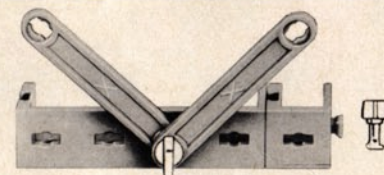

**Herstellen eines Gelenks durch S-Riegel 6 und Riegelscheibe.**  
 Making a joint with key-bolt 6 and blocking washer.  
 Realisation d'une articulation avec le rivet S 6 et un disque d'arrêt.  
 Formazione di un giunto mediante chiovistella 6 e rondella di fissaggio.  
 Het maken van een scharnier door S-grendel 6 en grendelschijf.

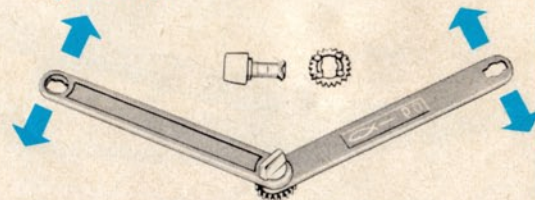

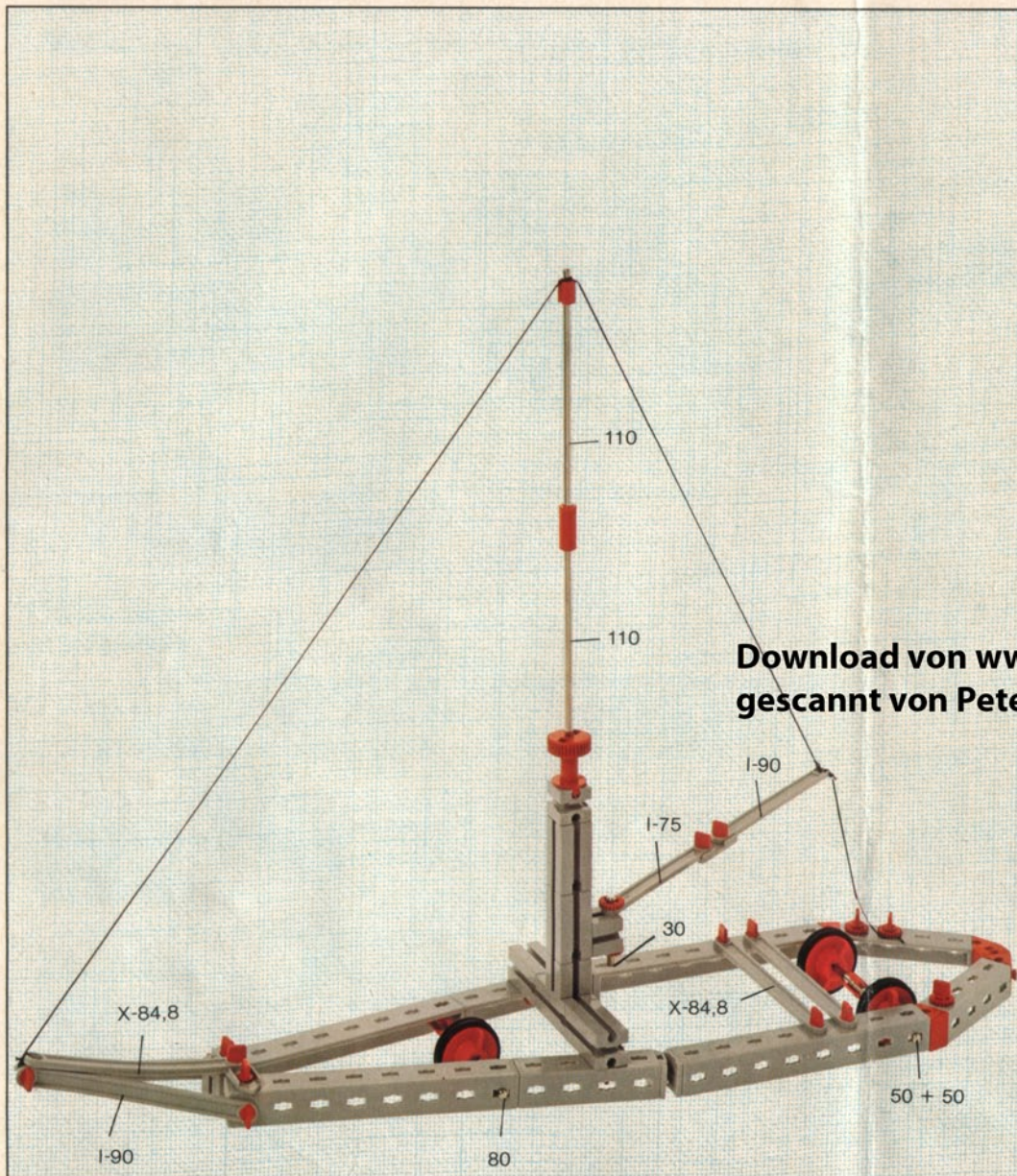

Download von [www.ft-fanarchiv.de](http://www.ft-fanarchiv.de)  
gescannt von Peter Remm

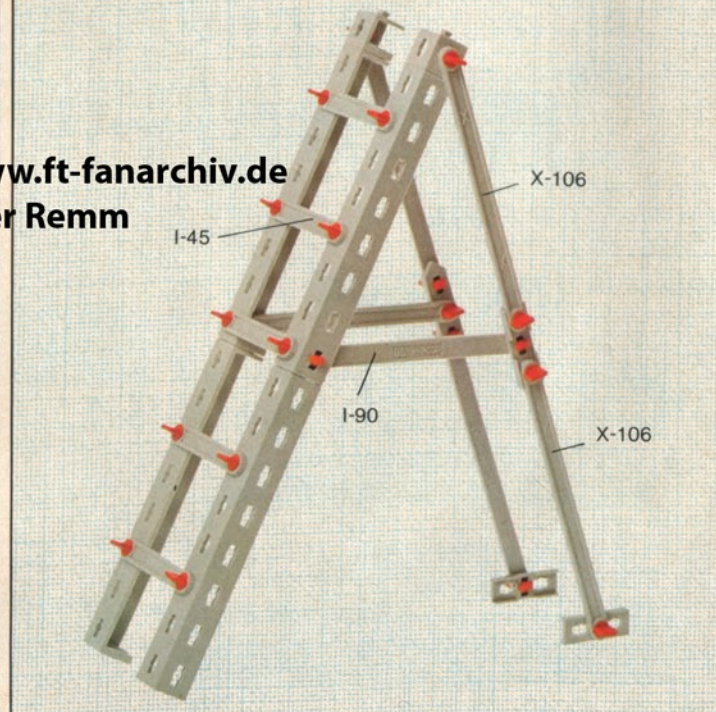
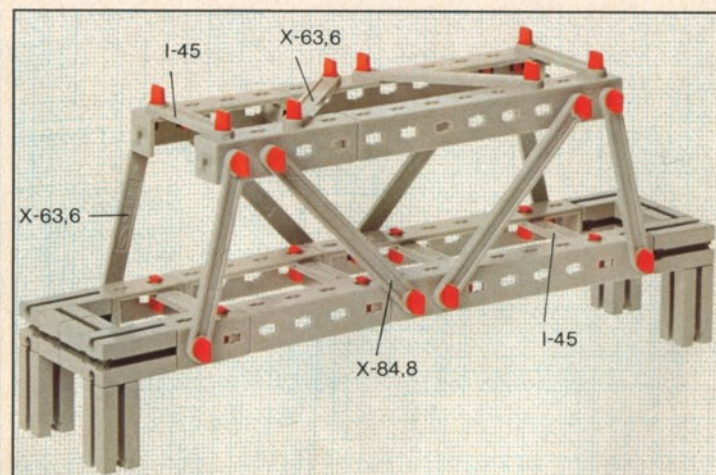

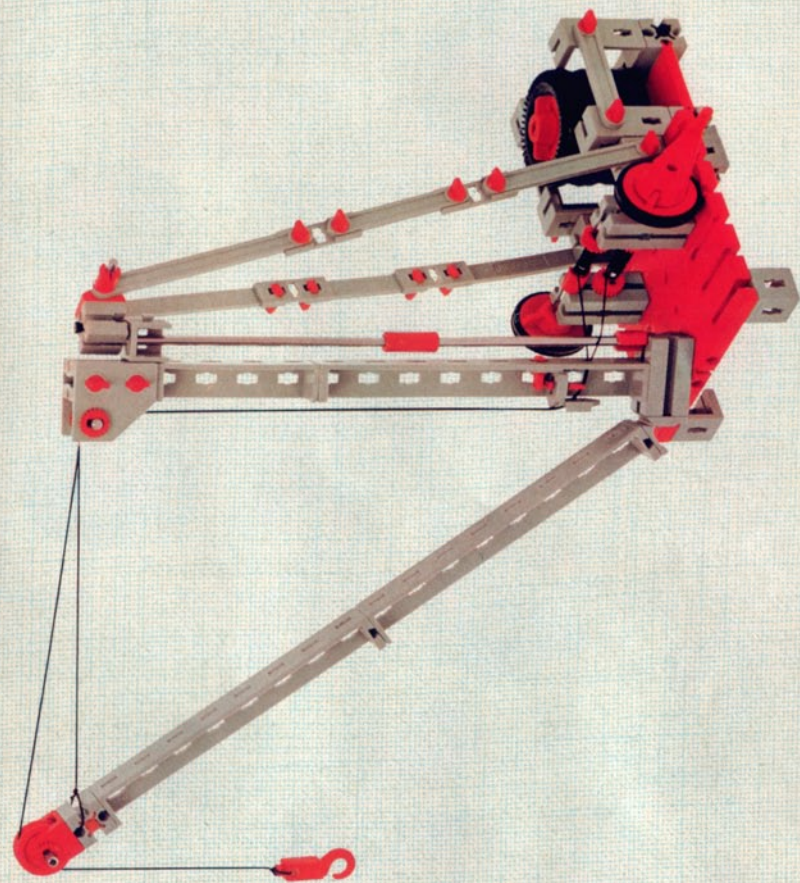
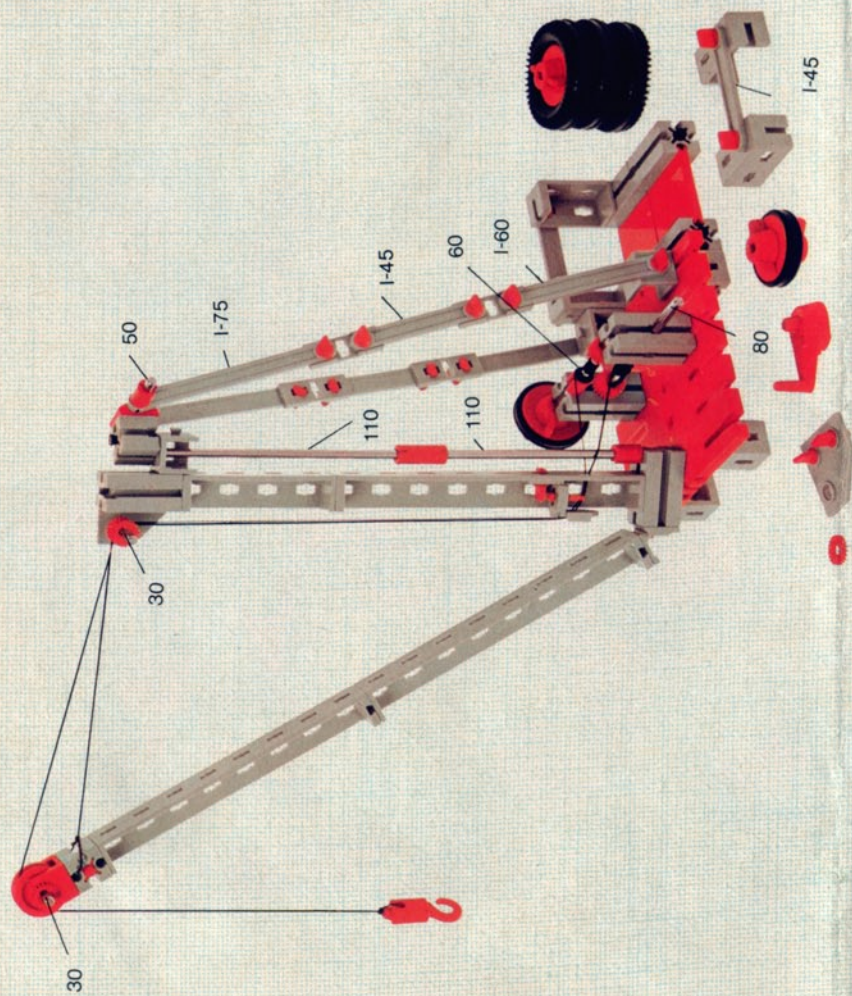

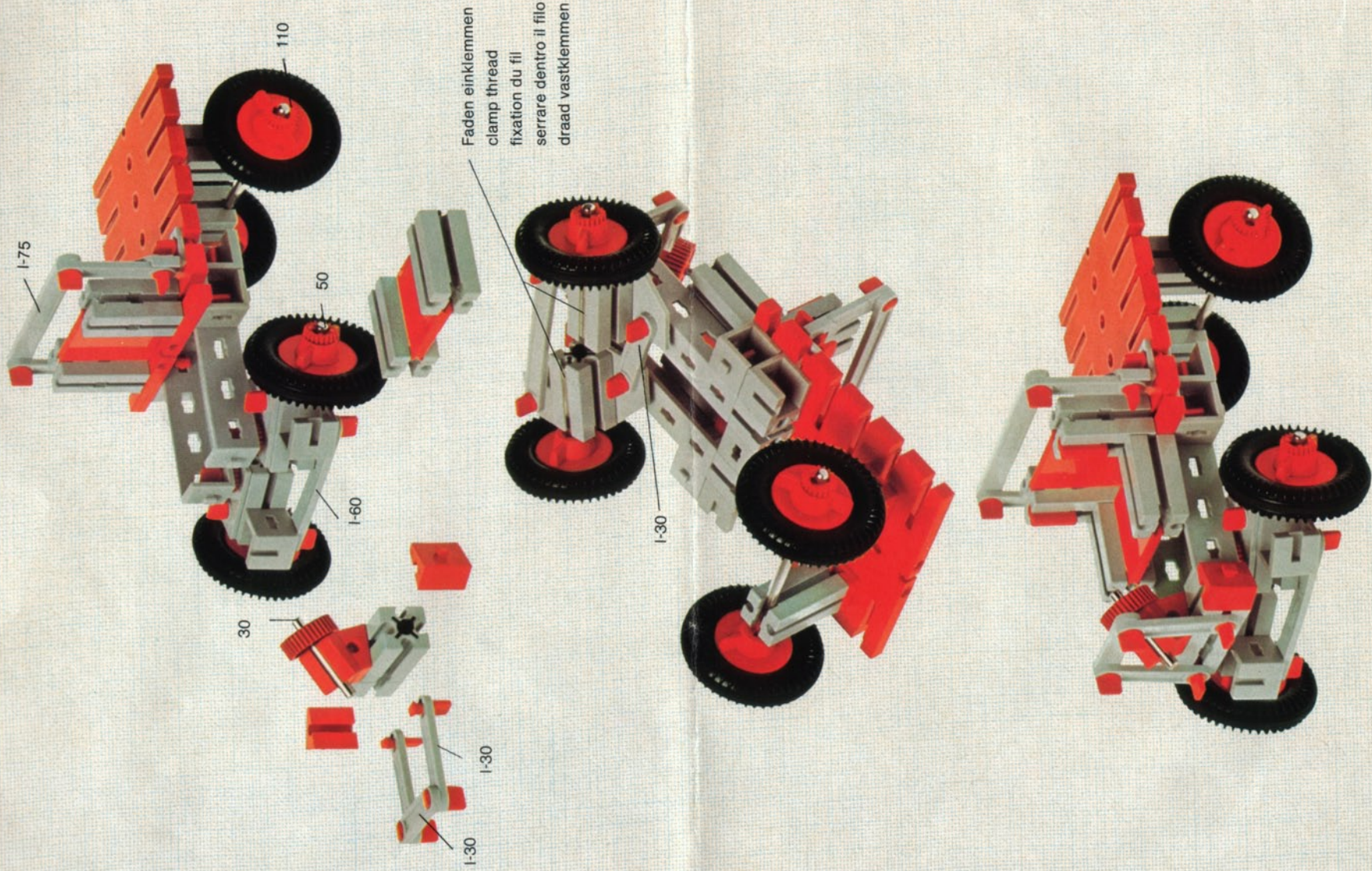

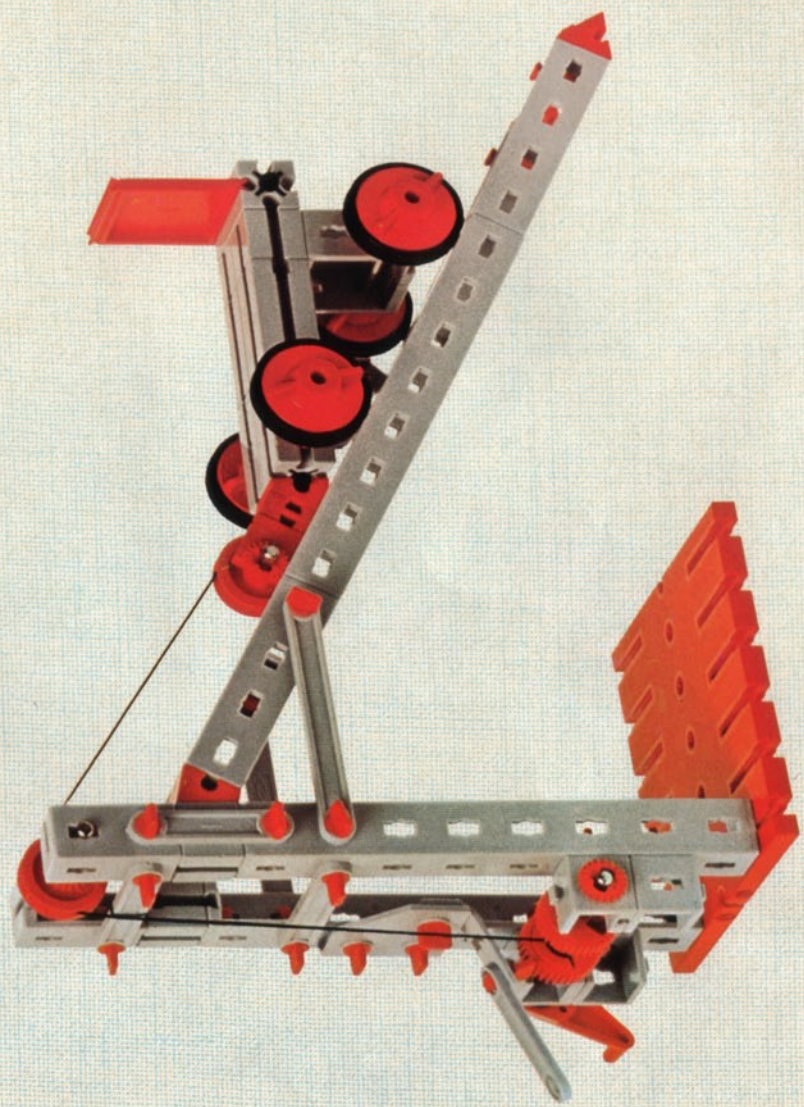
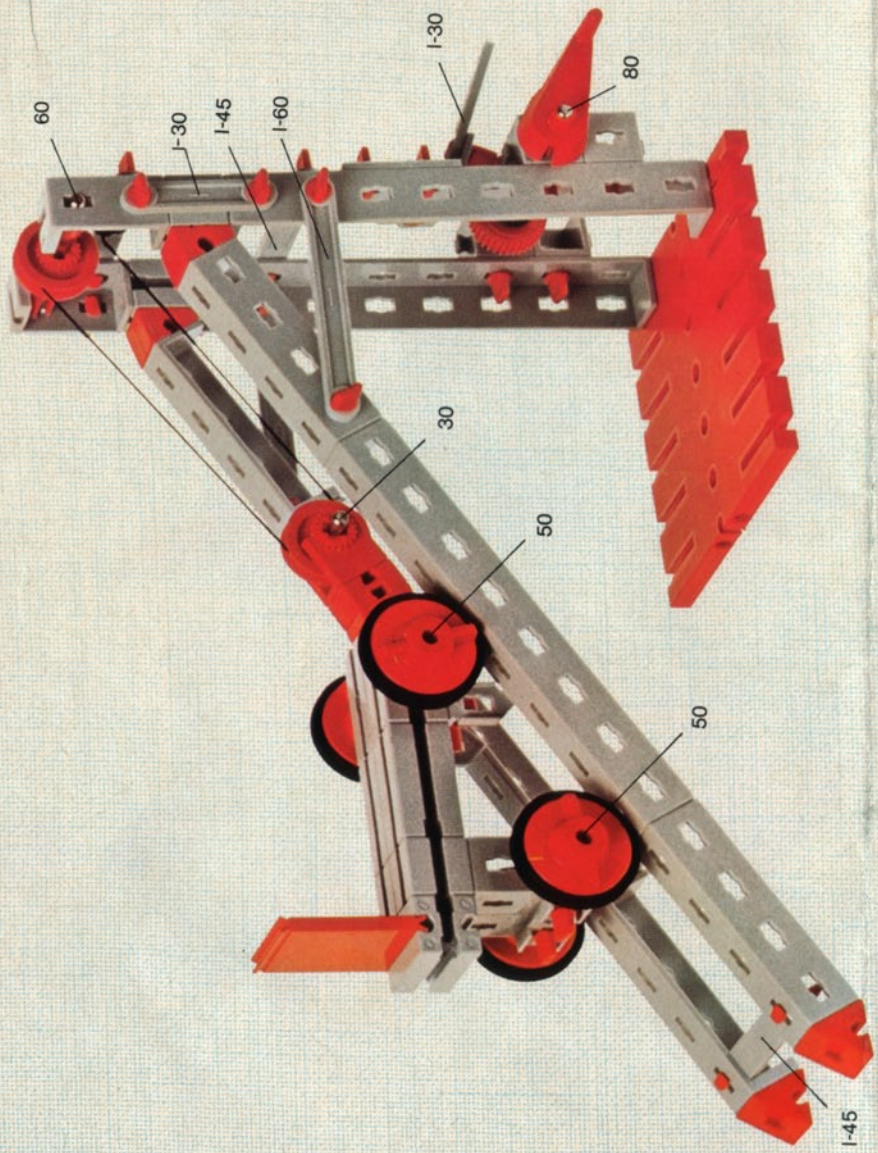

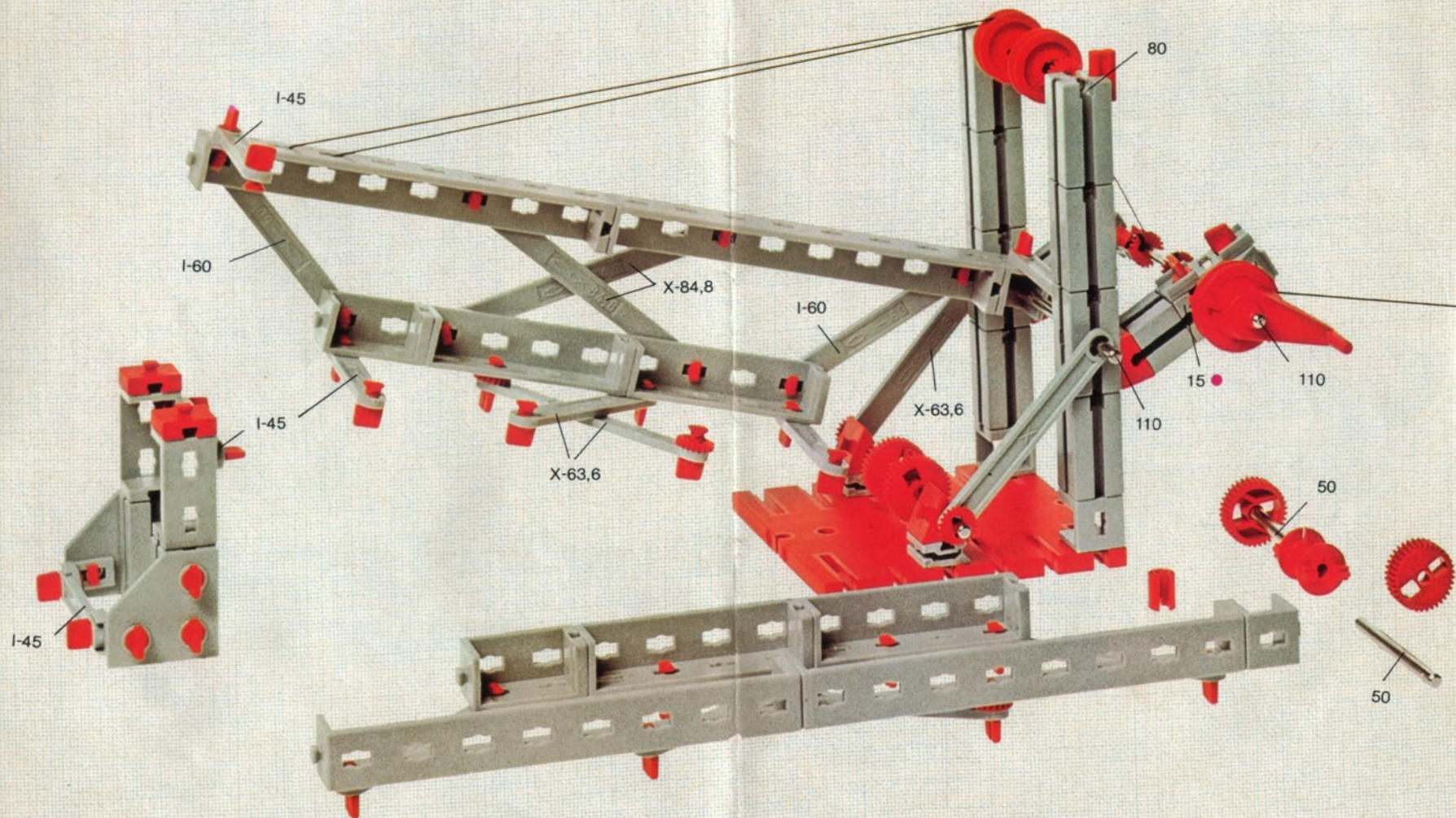



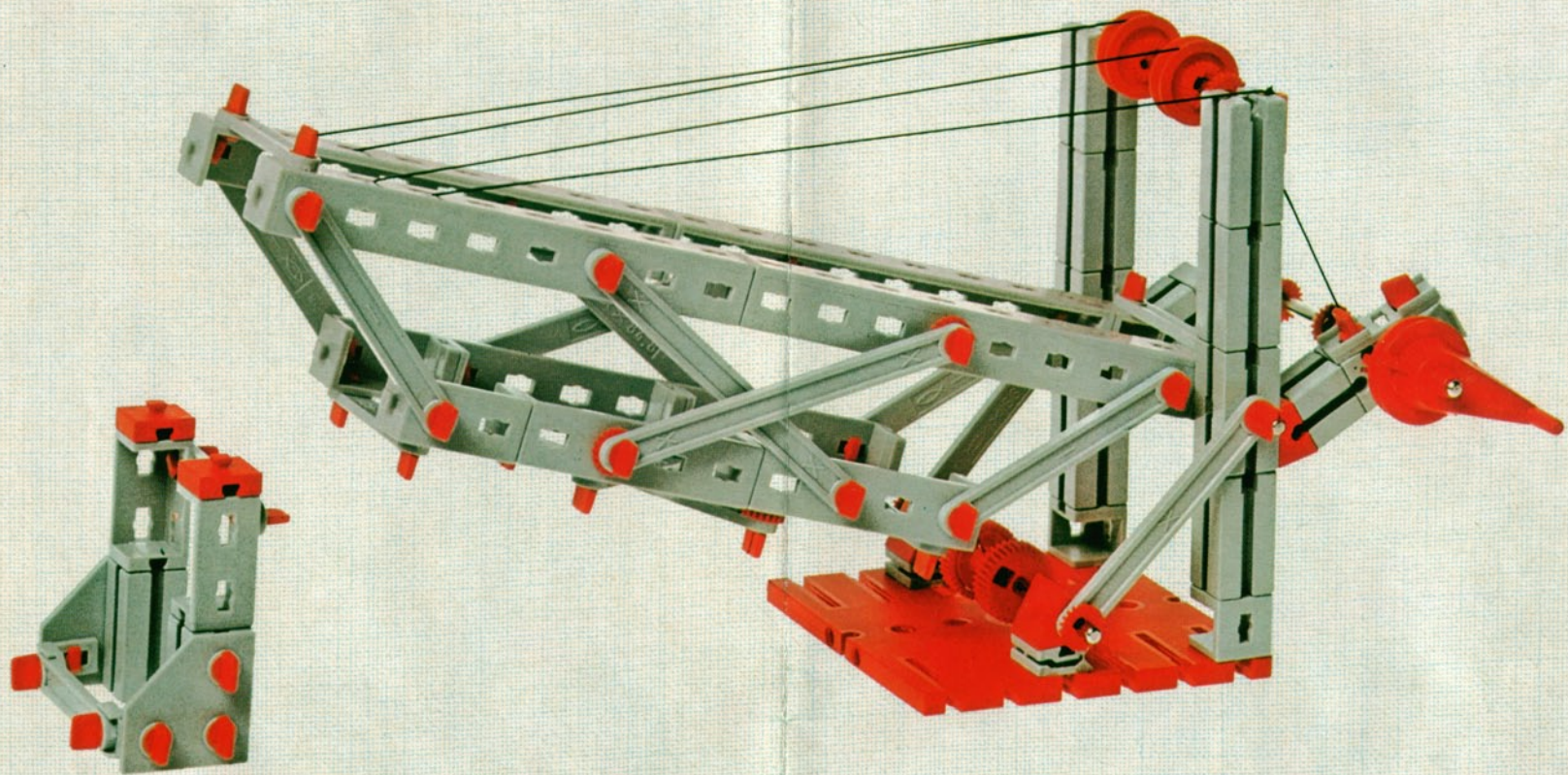

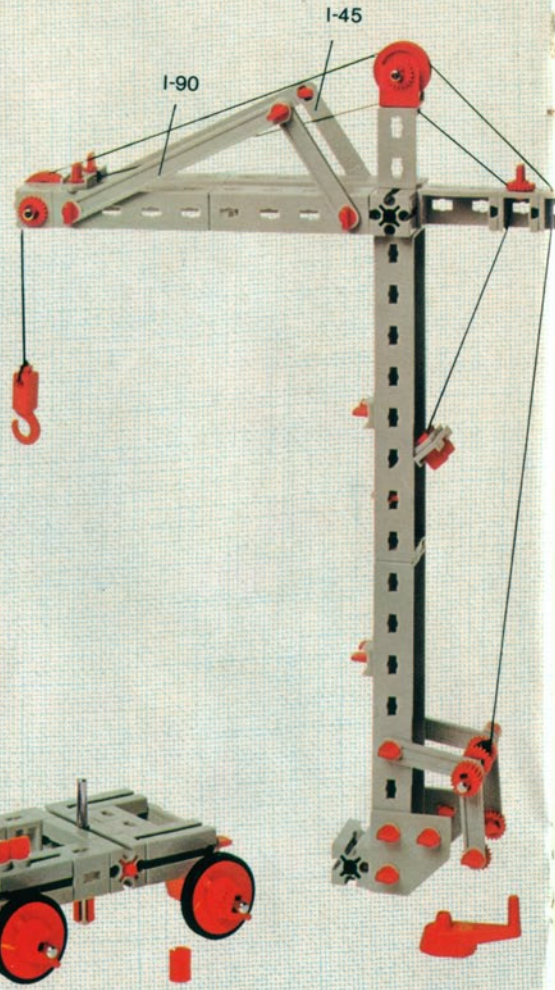
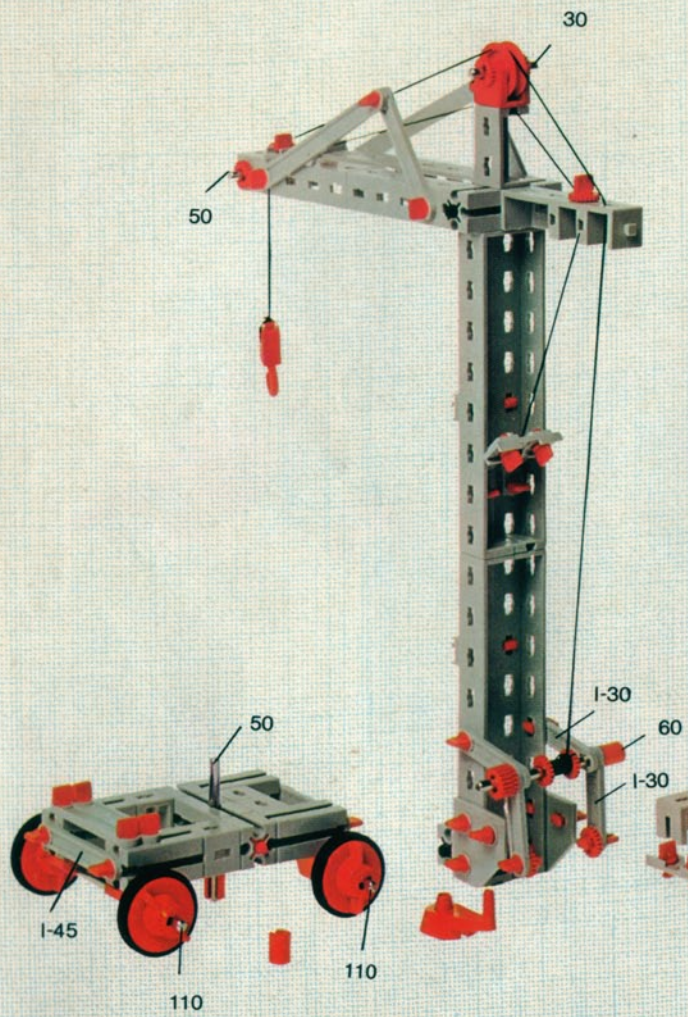

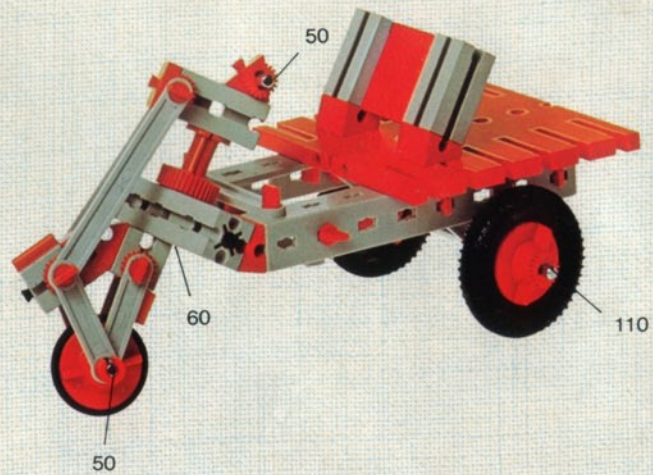
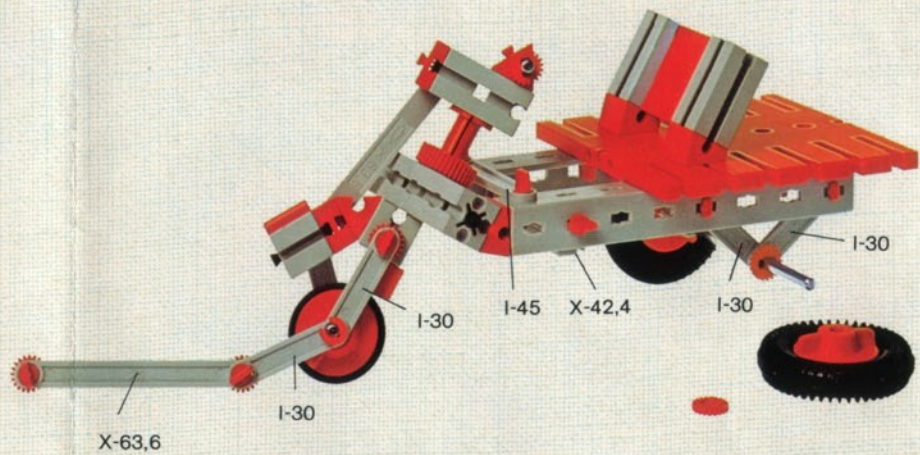
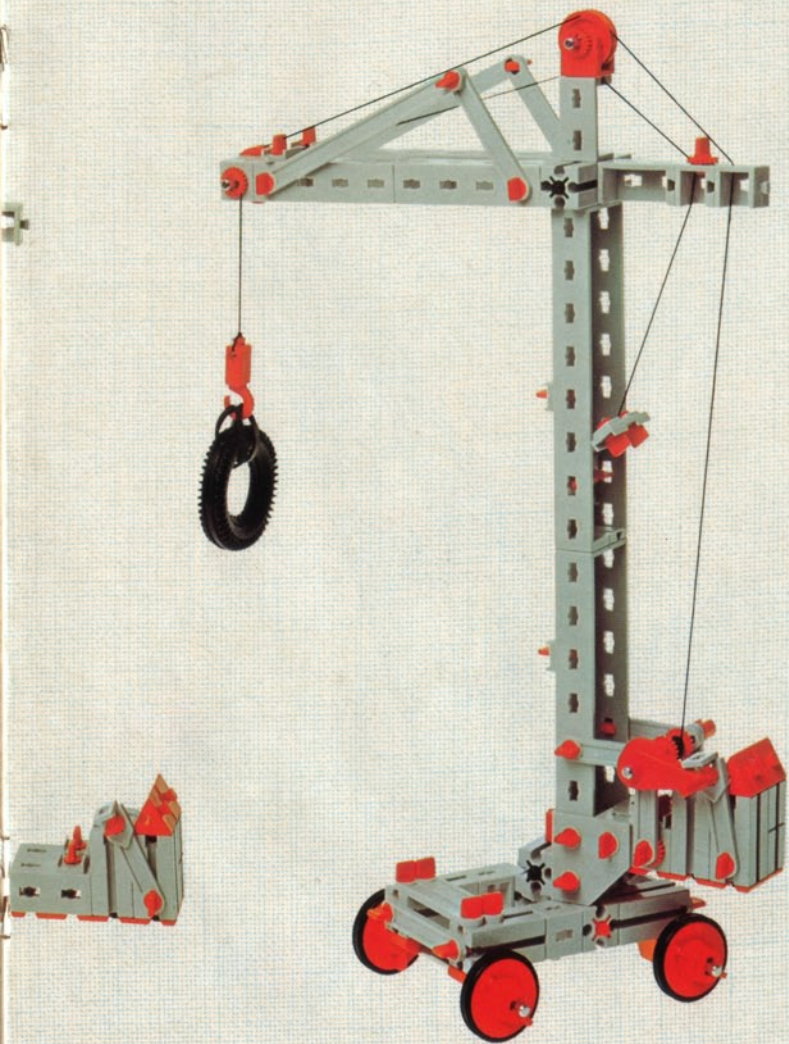

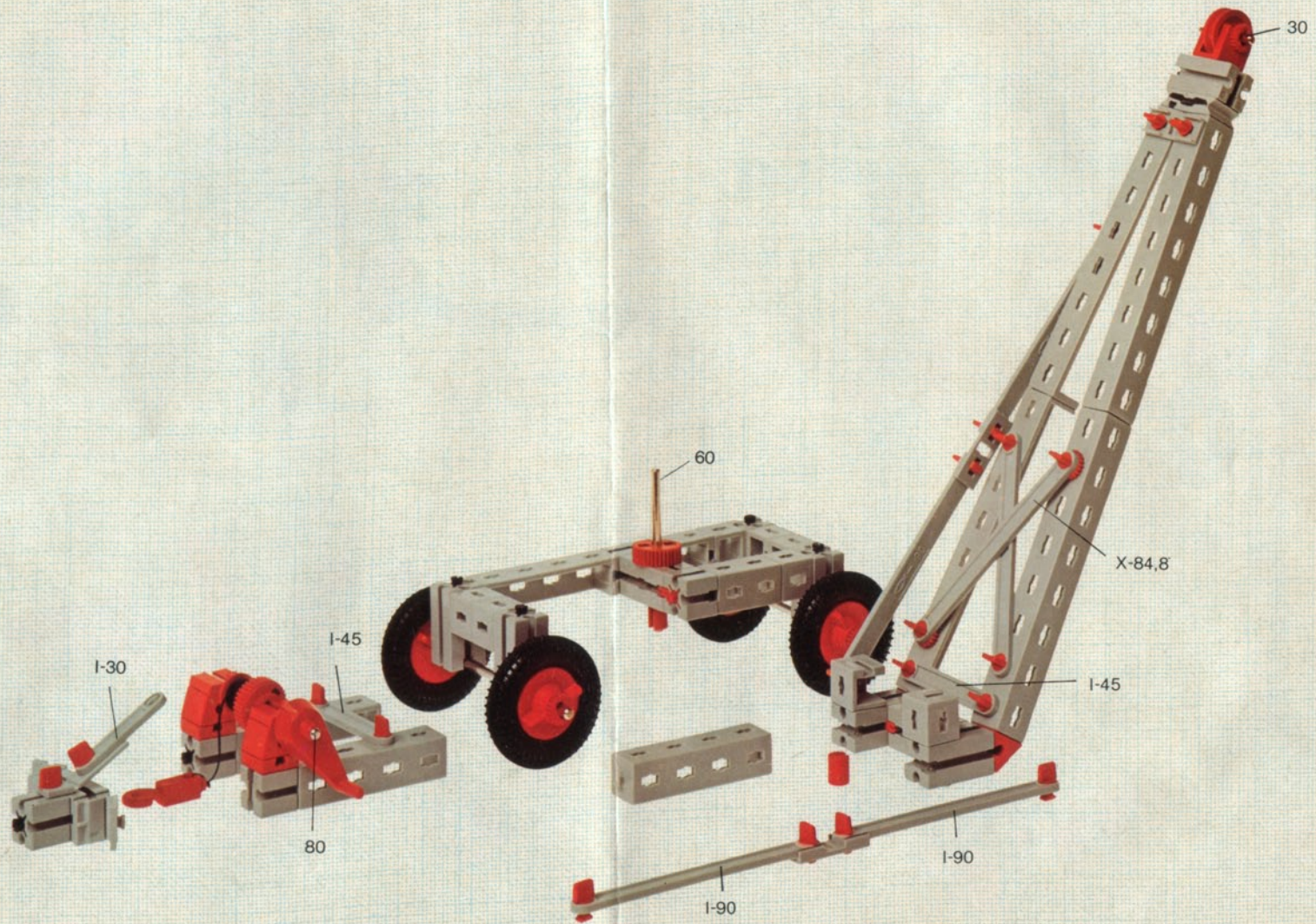

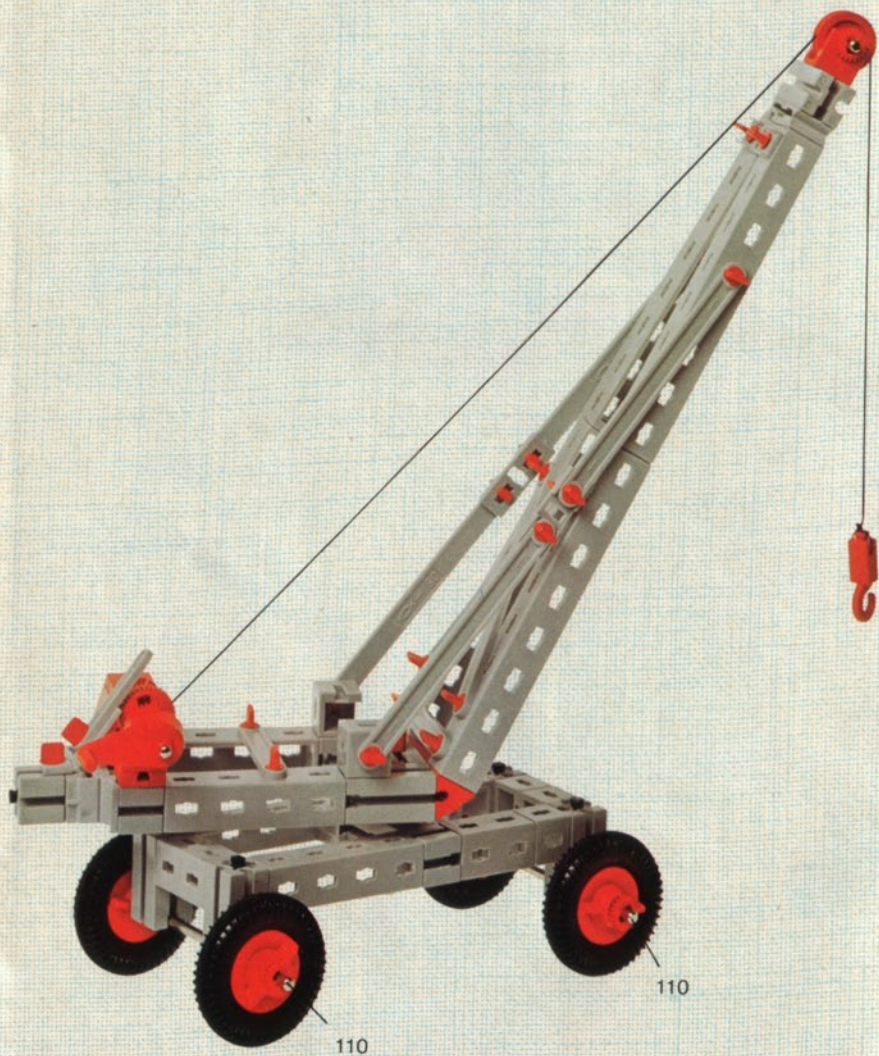





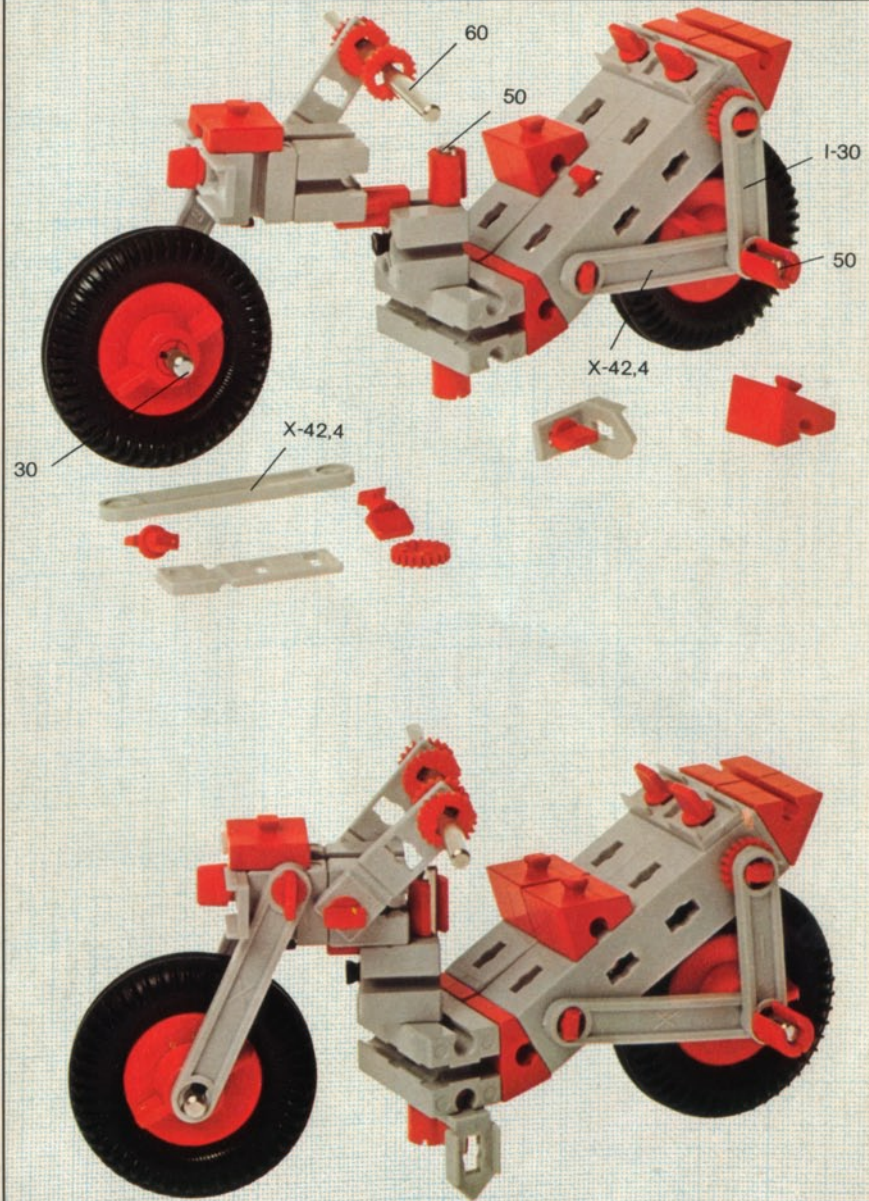

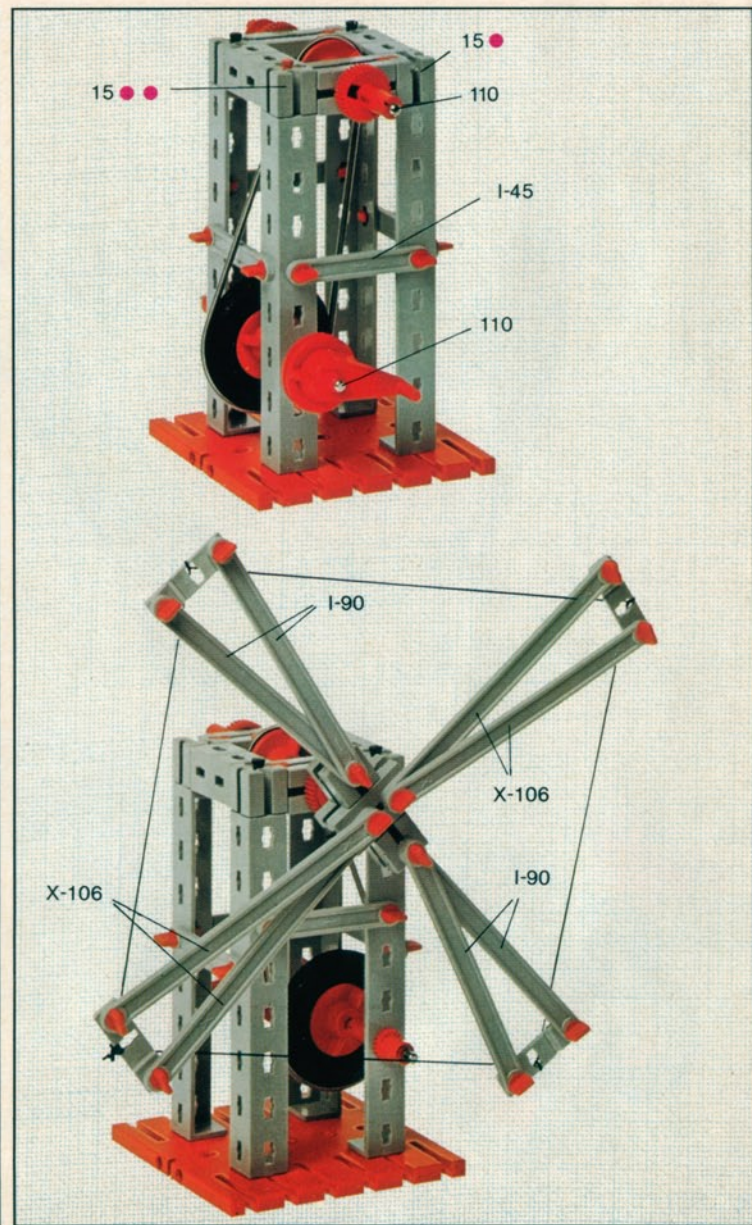
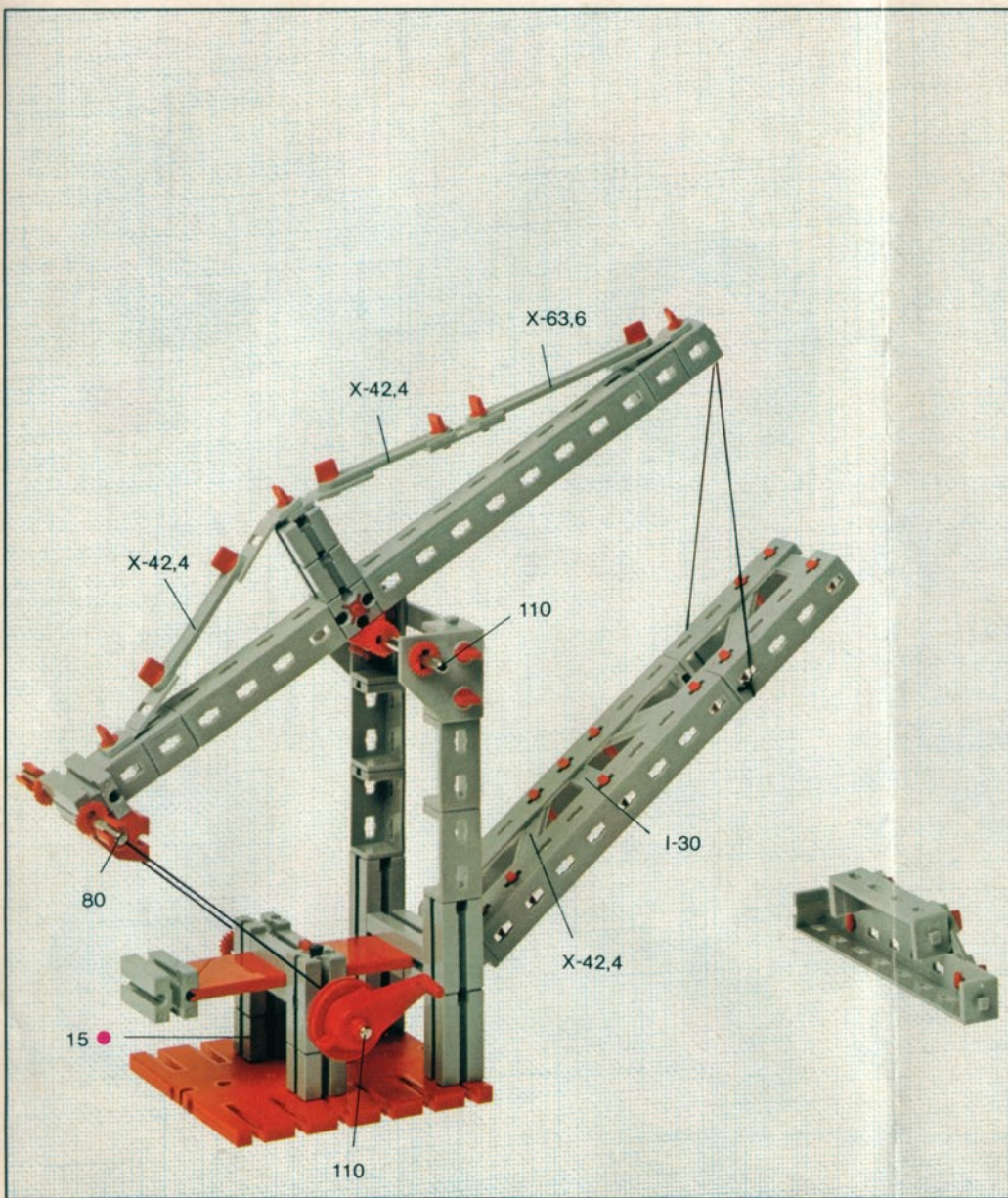



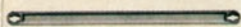













110

110



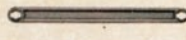

Stückliste · part list · nomenclature · elenco dei pezzi · onderdelenlijst					Stückliste · part list · nomenclature · elenco dei pezzi · onderdelenlijst						
Abbildung	Artikel- Nummer	50 S Stück	Benennung	Zusatz- kasten		Abbildung	Artikel- Nummer	50 S Stück	Benennung	Zusatz- kasten	
	4 36300 1	4	Winkelträger 15 · angle girder 15 · cornière de 15 · trave angolare 15 · hoekdraagsteun 15	ft051	2		4 36318 1	8	X-Strebe 106 · X-strut 106 · entretroise de 106 type X · diagonale X 106 · X-spant 106	ft056	4
	4 36304 1	4	Winkelträger 15 m. 2 Zapfen · angle girder 15 with 2 lugs · élément de 15 à 2 tenons · trave angolare 15 con 2 pemi- hoekdraagsteun 15 m. 2 kappen (penn.)	ft051	2		4 36326 1	4	Lasche 15 · fish-plate 15 · éclisse de 15 · coprigiunto 15 · rechtverbindingsstuk 15	ft053	4
	4 36301 1	4	Winkelträger 30 · angle girder 30 · cornière de 30 · trave angolare 30 · hoekdraagsteun 30	ft051	4		4 36327 1	2	Lasche 21,3 · fish-plate 21,3 · éclisse de 21,3 · coprigiunto 21,3 · rechtverbindingsstuk 21,3	ft053	4
	4 36302 1	4	Winkelträger 60 · angle girder 60 · cornière de 60 · trave angolare 60 · hoekdraagsteun 60	ft051	2		4 35738 1	4	Winkelasche · angle fish-plate · éclisse coudée · coprigiunto angolato · hoekverbindingsstuk	ft053	4
	4 36303 1	4	Winkelträger 120 · angle girder 120 · cornière de 120 · trave angolare 120 · hoekdraagsteun 120	ft051	4		4 36330 1	4	Gelenklasche · hinge plate · charnière · coprigiunto a snodo · scharnierverbindingsstuk	ft053	4
	4 36309 1	12	I-Strebe 30 · I-strut 30 · entretoise de 30 type I · diagonale I 30 · I-spant 30	ft055	4		4 36325 1	2	Eckknotenplatte · comer connector plate · gousset d'angle · piastra nodale angolare · hoekknoopplaat	ft053	2
	4 36310 1	8	I-Strebe 45 · I-strut 45 · entretoise de 45 type I · diagonale I 45 · I-spant 45	ft055	8		4 36323 1	60	S-Riegel 4 · key-bolt 4 · rivet de 4 · chiavistello 4 · grendel 4	ft052	40
	4 36311 1	4	I-Strebe 60 · I-strut 60 · entretoise de 60 type I · diagonale I 60 · I-spant 60	ft055	8		4 36324 1	10	S-Riegel 6 · key-bolt 6 · rivet de 6 · chiavistello 6 · grendel 6	ft052	16
	4 36312 1	8	I-Strebe 75 · I-strut 75 · entretoise de 75 type I · diagonale I 75 · I-spant 75	ft055	4		4 36457 1	6	S-Riegel 8 · key-bolt 8 · rivet de 8 · chiavistello 8 · grendel 8	ft052	16
	4 36313 1	4	I-Strebe 90 · I-strut 90 · entretoise de 90 type I · diagonale I 90 · I-spant 90	ft055	4		4 36334 1	12	Riegelscheibe · blocking washer · disque d'arrêt · rondella di fissaggio · grendelschijf	ft052	16
	4 36315 1	12	X-Strebe 42,4 · X-strut 42,4 · entretroise de 42,4 type X · diagonale X 42,4 · X-spant 42,4	ft056	8		4 36329 1	4	Scharnier · hinge · charnière · cemiera · schamier	ft053	8
	4 36316 1	8	X-Strebe 63,6 · X-strut 63,6 · entretroise de 63,6 type X · diagonale X 63,6 · X-spant 63,6	ft056	8		4 35800 1	1	S-Griff · key-boit tool · tourne-rivet · chiavetta · S-greep	ft052	1
	4 36317 1	4	X-Strebe 84,8 · X-strut 84,8 · entretroise de 84,8 type X · diagonale X 84,8 · X-spant 84,8	ft056	8						

